

# RDCD20



## MODULO DI RECUPERO SENZA VENTILATORI UTILIZZO IN SISTEMA CENTRALIZZATO

**Recuperatore di calore:** in controcorrente interamente realizzato in materiale plastico.

**Struttura:** autoportante in HMPEPS a tenuta completa di sistema estrazione filtri e drenaggio condensa.

**Filtri:** le unità sono provviste di serie con celle filtranti ondulate in fibra sintetica classe G4, in opzione filtro efficienza F7 su aria esterna.

## RECOVERY MODULE WITHOUT FANS USE IN CENTRALIZED SYSTEM

**Heat recovery:** heat exchanger of the type in countercurrent entirely made of plastic material.

**Structure:** free standing HMPEPS seal, complete of filters ex traction system and drain condensate.

**Filters:** the units are equipped with standard filter cells synthetic fiber efficiency G4, optional F7 efficiency on fresh air.

### FILTRI | FILTERS

Efficienza | Efficiency Standard

G4  
ISO COARSE > 65 %

Efficienza | Efficiency Optional

F7  
ISO e PM1 > 65 %



**DISEGNI | DRAWINGS**

PESO | WEIGHT: 7 kg

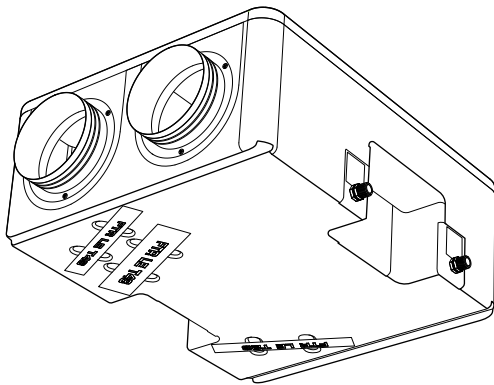

Vista dal basso | Bottom View

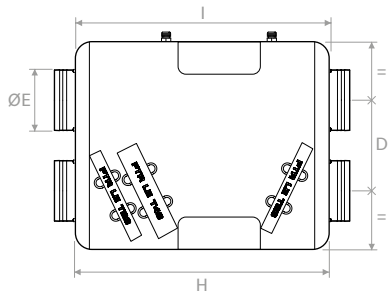

Vista interna | Internal view

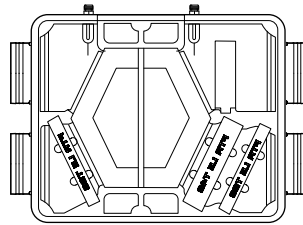

Vista laterale | Side view

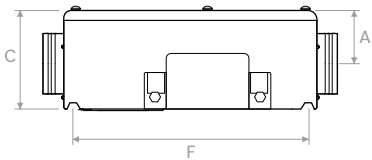

Vista frontale | Front view

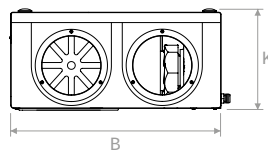

Vista in pianta | Plan view

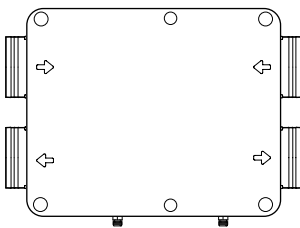

|    | A   | B   | C   | D   | ØE  | F   | H   | I   | K   |
|----|-----|-----|-----|-----|-----|-----|-----|-----|-----|
| mm | 149 | 550 | 255 | 243 | 156 | 620 | 670 | 770 | 268 |



# RDCD20

## DIAGRAMMI PRESTAZIONALI | PERFORMANCE CHARTS

SCAMBIATORE CERTIFICATO EN 308 | HEAT EXCHANGER EN 308 CERTIFIED

### RDCD20

#### Diagramma efficienza estiva

Aria esterna: 32 °C / 50 % U.R.

Aria ambiente: 26 °C / 50 % U.R.

#### Summer efficiency chart

Fresh air: 32 °C / 50 % R.H.

Return air: 26 °C / 50 % R.H.

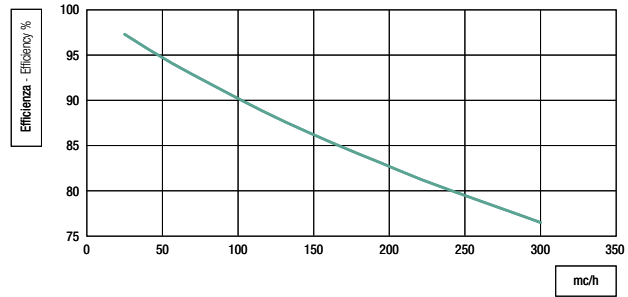

#### Diagramma efficienza invernale

Aria esterna: - 5 °C / 80 % U.R.

Aria ambiente: 20 °C / 50 % U.R.

#### Winter efficiency chart

Fresh air: -5 °C / 80 % R.H.

Return air: 20 °C / 50 % R.H.

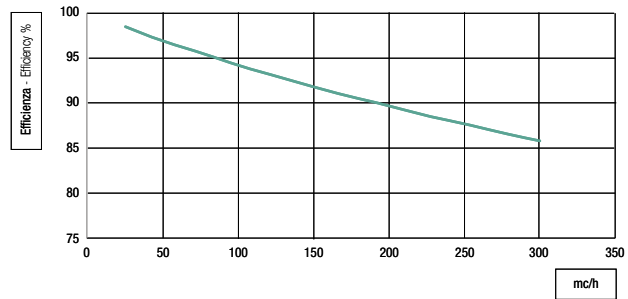

**PREZZI | PRICES**

---

| Modello   Model | Descrizione   Description                                                               | € |
|-----------------|-----------------------------------------------------------------------------------------|---|
| <b>RDCD20</b>   |                                                                                         | - |
| <b>FTRLET23</b> | Kit filtri ricambio (2 pz) efficienza G4   Replacement filter kit (2 pcs) efficiency G4 | - |
| <b>FTRLET48</b> | Filtro ricambio efficienza F7   Replacement filter efficiency F7                        | - |

